

Operating Instructions

XGS 7500/8500



Foreword

We are pleased to welcome you as a new customer of our Sophos XGS appliances.

To install and configure the hardware appliance you can use the following documents:

Hardware Quick Start Guide: Connection to the system peripherals in a few steps

Operating Instructions: Notes on the security and commissioning of the hardware appliance

Sophos Firewall How-To Library: Installing and configuring the software appliance

The Hardware Quick Start Guide and the Safety Instructions are also delivered in printed form together with the hardware appliance. The instructions must be read carefully prior to using the hardware and should be kept in a safe place.

You may download all user manuals and additional documentation from the support webpage at: sophos.com/support



Security Symbols

The following symbol and its meaning appears in the Hardware Quick Start Guide, Safety Instructions and in these Operating Instructions.

Caution and Important Note. If these notes are not correctly observed:

This is dangerous to life and the environment

- The appliance may be damaged
- The functions of the appliance will be no longer guaranteed
- Sophos shall not be liable for damages arising from a failure to comply with the Safety Instructions

Designed Use

The hardware appliances are developed for use in networks. The XGS 7500/8500 models may be operated as a standalone appliance. The hardware appliance can be used in commercial, industrial and residential environments.

The XGS 7500/8500 models belong to the appliance group A.

The hardware appliance must be installed pursuant to the current installation notes. Otherwise failure-free and safe operation cannot be guaranteed. The EU declaration of conformity is available at the following address:

Sophos Technology GmbH
Gustav-Stresemann-Ring 1
65189 Wiesbaden
Germany

CE Labeling, FCC and Approvals

The XGS 7500/8500 appliances comply with FCC Class A, CE, C-Tick, VCCI and UL.



Important Note: For computer systems to remain CE and FCC compliant, only CE and FCC compliant parts may be used. Maintaining CE and FCC compliance also requires proper cable and cabling techniques.

Operating Elements and Connections

XGS 7500

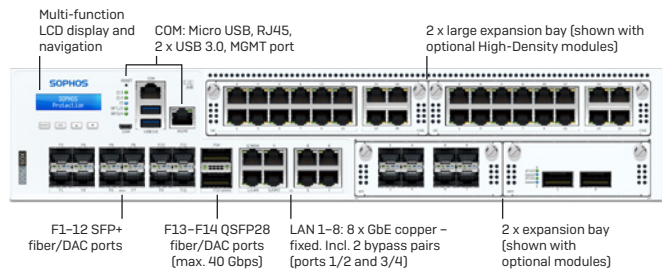

XGS 8500

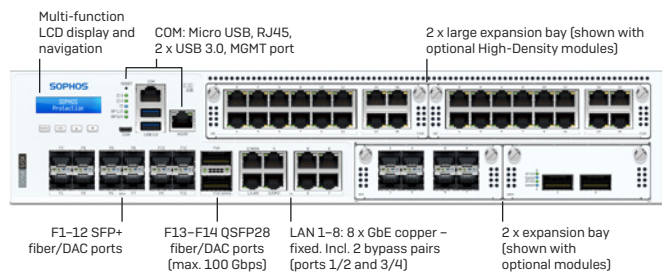

XGS 7500/8500

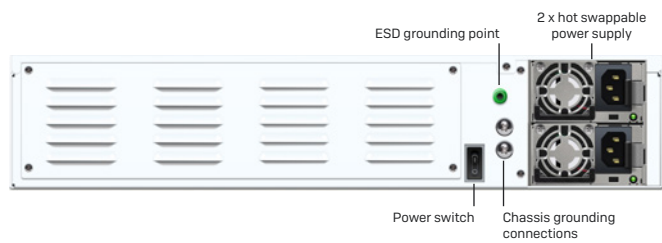

Interfaces (front)

LAN Ports	Type	Speed	Comment
1-8	RJ45	10/100/1000 Mbps	Ports 1/2 and 3/4 can be configured as independent bypass pairs.
F1-F12	SFP+	1/10 Gbps	SFP/SFP+ transceivers are sold separately.
F13-F14	QSFP28	1/10/25/40 Gbps [XGS 7500] 1/10/25/40/50/100 Gbps [XGS 8500]	

Other Ports	Type	Comment
COM	RJ45/Micro USB	You can connect a serial console to either the RJ45 or micro USB COM port to access the CLI. Only one port can be used at any time. If both ports are connected then the micro USB port will take precedence. The required connection settings are: <ul style="list-style-type: none"> • Bits per second: 38,400 • Data bits: 8 • Parity: N (none) • Stop bits: 1
USB	USB 3.0 (Type A)	You can connect a USB 2.0 or 3.0 compatible device to this port (e.g. USB thumb drive, UPS, 3G/4G dongles).
MGMT	RJ45 (10/100/1000 Mbps)	We recommend using this dedicated port to connect your Admin PC.
Reset	Button [Front]	Press and hold for >10 seconds to reset the unit to factory default settings. All configuration, reports and patterns will be deleted.

Module Slots*	Type	Comment
A/B	Flexi Port	Can be used for any Flexi Port module listed in the table below.
C/D	High-density Flexi-Port module	Can be used for the High-density Flexi-Port module listed in the table below.

Compatible Modules**	Comment
8 port GbE copper	Flexi Port
8 port GbE SFP	Flexi Port
8 port 10 GbE SFP+	Flexi Port
4 port GbE copper – 2 Bypass groups	Flexi Port
2 port 40 GbE QSFP+	Flexi Port
4 port 10 GbE SFP+	Flexi Port
2 port GbE fiber (LC) Bypass + 4 port GbE SFP	Flexi Port
2 port 10 GbE fiber (LC) Bypass + 4 port 10 GbE SFP+	Flexi Port
4 port 2.5 GbE copper + 12 port GbE High-Density module***	High-density Flexi Port

* All the modules used in these slots are NOT Hot Swappable.

** SFP/SFP+/QSFP transceivers are sold separately.

*** Please note: For electromagnetic reasons, please only use shielded RJ45 Ethernet cables on the indicated ports of this module.

Technical Specifications

	XGS 7500	XGS 8500
Physical Specification		
No. of Fixed Ethernet Ports	22	22
No. of Fixed Bypass Port Pairs	2	2
Max. Ports via Flexi Modules	48	48
No. of Cores Main CPU	32/64	64/128
Main Memory	128 GB DDR4 ECC 3200	256 GB DDR4 ECC 3200
No. of Cores NPU	36	36
NPU Memory	24 GB DDR4 2667 ECC	24 GB DDR4 2667 ECC
Storage	2 x 960 GB NVMe	2 x 960 GB NVMe
Power Supply	1+1 Internal auto-ranging 100-240VAC, 50-60 Hz hot swap	1+1 Internal auto-ranging 100-240VAC, 50-60 Hz hot swap
Power Consumption (idle)	306 W/1044 BTU/h	318 W/1085 BTU/h
Power Consumption (full load)	635 W/2165 BTU/h	645 W/2200 BTU/h
Mounting	2U sliding rails (included) min. rack depth: 588mm [23.125"] max. rack depth: 870mm [34.25"]	2U sliding rails (included) min. rack depth: 588mm [23.125"] max. rack depth: 870mm [34.25"]
Dimensions Width x Depth x Height	438 x 645 x 88 mm 17.24 x 25.39 x 3.46 inches	438 x 645 x 88 mm 17.24 x 25.39 x 3.46 inches
Weight (kg) unpacked/packed	18 kg/39.68 lbs (unpacked) 27.3 kg/60.19 lbs (packed)	18 kg/39.68 lbs (unpacked) 27.3 kg/60.19 lbs (packed)
Environmental		
Noise level (avg.) (Typical/Max Operation)	72.5/80 dBA	72.5/80 dBA
Operating Temperature	0°C to 40°C	0°C to 40°C
Storage Temperature	-20°C to 70°C	-20°C to 70°C
Operational/Storage Humidity	10% to 90% non-condensing	10% to 90% non-condensing
Operational/Storage Altitude	2000/5791 m	2000/5791 m
MTBF (hours) [Telcordia SR-332 Issue 3]	123320	123320
Certifications (Safety, EMC)	CB, CE, UL, FCC, ISED, VCCI, CCC, KC, BSMI, RCM, NOM, Anatel	CB, CE, UL, FCC, ISED, VCCI, CCC, KC, BSMI, RCM, NOM, Anatel

LED Status

Status LEDs			
Power 1 (Upper Power Supply)	Green	Solid	Power Supply 1 Active.
	Red	Solid	Power Supply 1 Failure.
	Off		Power Supply not present
Power 2 (Lower Power Supply)	Green	Solid	Power Supply 2 Active.
	Red	Solid	Power Supply 2 Failure.
	Off		Power Supply not present
SSD	Blue	Flashing	SSD reading/writing data.
BP 1/2	Green	Solid	Bypass mode on Ports 1/2 enabled.
		Off	Bypass mode on Ports 1/2 disabled and inactive.
BP 3/4	Green	Solid	Bypass mode on Ports 3/4 enabled.
		Off	Bypass mode on Ports 3/4 disabled and inactive.

LEDs on each RJ45 Ethernet connector			
ACT/LNK (Left LED)	Green	Solid	1. The Ethernet port has established link. 2. Good connection between the Ethernet port and hub.
		Flashing	The adapter is sending or receiving network data.
		Off	1. The adapter and switch are not receiving power. 2. No connection between both ends of network. 3. Network drivers have not been loaded or do not function correctly.
Speed (Right LED)	Amber	On	If Ethernet port is operating at 1 Gbps.
		Green	If Ethernet port is operating at 100 Mbps.
		Off	If Ethernet port is operating at 10 Mbps.

LEDs on each SFP+ connector			
ACT/LNK (Left LED)	Green	Solid	1. The SFP+ connector is receiving power. 2. Good connection between the SFP+ port and hub.
		Flashing	The adapter is sending or receiving network data.
		Off	1. The adapter and switch are not receiving power. 2. No connection between both ends of network. 3. Network drivers have not been loaded or do not function correctly.
Speed (Right LED)	Blue	On	If SFP+ connector is operating at 10 Gbps.
		Amber	If SFP+ connector is operating at 1 Gbps.
		Off	Either the LED is not working or the SFP+ connector is operating at a speed below 1 Gbps.

LEDs on each QSFP28 connector			
ACT/LNK (Left LED)	Green	Solid	1. The QSFP28 connector is receiving power. 2. Good connection between the QSFP28 port and hub.
		Flashing	The adapter is sending or receiving network data.
		Off	1. The adapter and switch are not receiving power. 2. No connection between both ends of network. 3. Network drivers have not been loaded or do not function correctly.
Speed (Right LED)	Blue	Slow single blink	If QSFP28 connector is operating at 25 Gbps (XGS 7500/8500) or 100 Gbps (XGS 8500 only).
		Slow double blink	If QSFP28 connector is operating at 50 Gbps (XGS 8500 only).
		Solid	If QSFP28 connector is operating at 10 or 40 Gbps.
	Amber	On	If QSFP28 connector is operating at 1 Gbps.
		Off	Either the LED is not working or the QSFP28 connector is operating at a speed below 1 Gbps.

Back side			
Power Supply	Green	Solid	Power.
		Flashing	AC connected but unit is off.
		Off	No power.

LCD and Control Keys

The XGS 7500/8500 have an LCD and an operating unit with four membrane keys. In the LCD, 16 characters per line can be displayed.

SOPHOS
Protection

Firmware Version
SFOS xx.xx.xx

While the security appliance is booting this message is displayed

Firmware Version





LCD Menu Details

Firmware Version SFOS xx.xx.xx			
Main Menu 1. System Menu	System Menu 1. Show Date	Fri 16 Apr 2023 12:54:32 GMT	
Port 1[LAN]	System Menu 2. Show Uptime	System uptime 0 days 0:26	
	System Menu 3. Show CPU	CPU Usage 0.00%	
	System Menu 4. Show Memory	Memory Usage Used: 7.60%	
	System Menu 5. Show LoadAvg	Load Average 0.89 0.89 0.78	
	System Menu 6. Show Disk	Show Disk 1. Total Usage	Total Disk Usage 0.02
		Show Disk 1. Detail Usage	Root 1% Temp 0% Config 9% Signature 1%
	System Menu 7. Live Users	Live Users 0	
Main Menu 2. Network Menu	Network Menu 1. Show Port 1[LAN]	Port 1[LAN] 172.16.16.16	
	Network Menu 2. Show Port 2[WAN]	Port 2[WAN] IP NOT ASSIGN	
	Network Menu 3. Show Port 3[NA]	Port 3[NA] IP NOT ASSIGN	
	Network Menu 4. Show All	Port 4[LAN] 172.16.16.16	
		Port 5[WAN] IP NOT ASSIGN	
		Port 6[NA] IP NOT ASSIGN	
		Port 7[NA] IP NOT ASSIGN	
		Port 8[NA] IP NOT ASSIGN	
	Network Menu 5. Show Gateway	GW1: Port 2 10.0.0.254	
Main Menu 3. Firmware Menu	Network Menu 1. Show Firmware	FW1=SFOS 15.01.0 Beta	
	Network Menu 2. Factory Reset	Factory Reset 1. v to Cont.	
		Factory Reset 2. Confirm	
	Network Menu 3. Shutdown	Shutdown 1. v to Cont.	
		Shutdown 1. Confirm	
	Network Menu 4. Reboot	Reboot 1. v to Cont.	
		Reboot 1. Confirm	
Main Menu 4. HA Info	Not Configured		











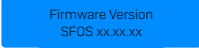

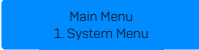

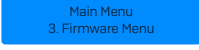
Executable Actions

- **Factory reset:** All settings are reset to the factory settings. The factory reset function sets all of the configuration settings and options to their original state. All data entered after the initial installation will be deleted, including the HTTP proxy cache, the entire email queue, accounting and reporting data, passwords, and uninstalled Up2Date packages. The version of the software will not change. That is, all firmware and pattern updates that have been installed will be retained.
- **Shut down:** The security appliance is shut down. The shut down action allows you to turn off the system, and allows you to cleanly stop all running services.
- **Reboot machine:** The security appliance is rebooted. The reboot action will shut down the system completely and reboot.



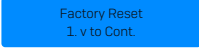

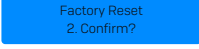

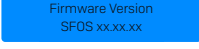



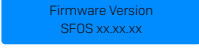

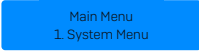

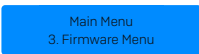
Control Key Functions

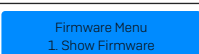
-  The current menu is left. When the key is pressed a couple of times, the modifications are discarded and the initial state will be displayed.
-   These keys are used to switch between the different menus and/or characters.
-  Pressing executes the configured action.

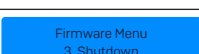

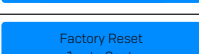

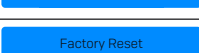

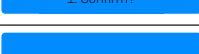



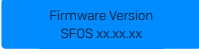

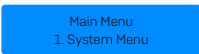

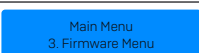

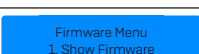
Factory Reset

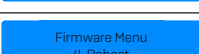
S.NO.	Action Item/press	What you see on the LCD	What it means
1.			Appliance is booting
2.			Appliance has finished Booting
3.			Shows Main Menu first item
4.	 x2		Shows Main Menu Third item
5.			Enters Into Firmware Menu
6.			Shows Firmware Menu Second item
7.			Press down key to continue
8.			Asks for Confirmation
9.			Factory Reset under progress
10.			Factory Reset Complete

Shut Down

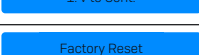
S.NO.	Action Item/press	What you see on the LCD	What it means
1.			Appliance is booting
2.			Appliance has finished Booting
3.			Shows Main Menu first item
4.	 x2		Shows Main Menu Third item
5.			Enters Into Firmware Menu
6.	 x2		Shows Firmware Menu Third item
7.			Press down key to continue
8.			Asks for Confirmation
9.			Shutdown Complete

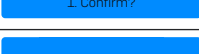
Reboot Machine

S.NO.	Action Item/press	What you see on the LCD	What it means
1.			Appliance is booting
2.			Appliance has finished Booting
3.			Shows Main Menu first item
4.	 x2		Shows Main Menu Third item
5.			Enters Into Firmware Menu
6.	 x3		Shows Firmware Menu Fourth item
7.			Press down key to continue
8.			Asks for Confirmation
9.			Reboot under progress
10.			Reboot Complete

Putting into Operation

Scope of Supply

The supplied parts are indicated in the Hardware Quick Start Guide.

Mounting Instructions

The XGS 7500/8500 appliances are designed for use in racks. Please consider the following security tips:



Important note: Functional reliability outside of a rack cannot be guaranteed.



Warnings and Precautions

The appliance can be operated safely if you observe the following notes and the notes on the appliance itself.

Rack Precautions

- Ensure that the leveling jacks on the bottom of the rack are fully extended to the floor with the full weight of the rack resting on them.
- In single rack installation, stabilizers should be attached to the rack.
- In multiple rack installations, the racks should be coupled together.
- Always make sure the rack is stable before extending a component from the rack.
- You should extend only one component at a time—extending two or more simultaneously may cause the rack to become unstable.

General Server Precautions

- Installation must be performed by qualified personnel.
- Review the electrical and general safety precautions that came with the components you are adding to your appliance.
- Determine the placement of each component in the rack before you install the rails.
- Install the heaviest server components on the bottom of the rack first, and then work up.
- Allow the hot plug power supply modules to cool before touching them.
- Always keep the rack's front door, all panels and server components closed when not servicing to maintain proper cooling.

Rack Mounting Considerations

Ambient operating temperature: If installed in a closed or multi-unit rack assembly, the ambient operating temperature of the rack environment may be greater than the ambient temperature of the room. Therefore, you should install the equipment in an environment compatible with the manufacturer's maximum rated ambient temperature.

- ▶ **Reduced airflow:** Equipment should be mounted into a rack with sufficient airflow to allow cooling.
- ▶ **Mechanical loading:** Equipment should be mounted into a rack so that a hazardous condition does not arise due to uneven mechanical loading.
- ▶ **Circuit overloading:** Consideration should be given to the connection of the equipment to the power supply circuitry and the effect that any possible overloading of circuits might have on overcurrent protection and power supply wiring. Appropriate consideration of equipment nameplate ratings should be used when addressing this concern.
- ▶ **Reliable ground:** Reliable grounding must be maintained at all times. To ensure this, the rack itself should be grounded. Grounding screws for the appliance are on the rear of the chassis. Chassis Grounding is required. Particular attention should be given to power supply connections other than the direct connections to the branch circuit (i.e., the use of power strips, etc.).

Rack Mounting Instructions

To mount the appliance to the rack you need the delivered rack-mount kits. There are a variety of rack units on the market, which may mean the assembly procedure will differ slightly. You should also refer to the installation instructions that came with the rack unit you are using.

Because of their dimension and weight the XGS 7500/8500 models are delivered with a special rail kit.



Important note: Make sure you use the screws supplied with the rack-mount brackets. Using the wrong screws could damage the hardware appliance and would invalidate your warranty. Please observe the mounting instructions for your rack.

1. Attach the rack-mount brackets to the appliance:

- ▶ Place the appliance on a hard flat surface with the front panel facing you.
- ▶ Attach the rack-mount brackets to the left and right side of the appliance with the supplied screws.
- ▶ Make sure the brackets are properly attached to the appliance.



Important note: Please check the technical specs above for the min. and max. rack depth.

2. Choose the rack location:

- ▶ Leave enough clearance in front of the rack so that you can open the front door completely (~60 cm/25 inches).
- ▶ Leave approximately 80 cm/30 inches of clearance in the back of the rack to allow for sufficient airflow and ease in servicing.
- ▶ This product is for installation only in a restricted access location (dedicated equipment rooms, service closets and the like).

3. Install the sliding rails:

- ▶ Please refer to the dedicated Sliding Rails Mounting Instructions shipped with the appliance.

Connection and Configuration

How to connect the appliance is described in the Hardware Quick Start Guide. For configuration you can follow the initial setup wizard described in the WebAdmin Quick Start Guide or cancel it and perform a manual setup (see the [Sophos Firewall How-To Library](#)).

SW - RAID (SSD) System

The XGS 7500/8500 models are equipped with a RAID-1 system with two Solid State Drives. A RAID system (redundant array of independent disks) connects several physical Solid State Drives to one particularly performing logical drive. RAID-1 enhances the data security and consistency of your system by mirroring all data of the first SSD to the second redundant SSD. If one of the SSDs fails, your system will still be fully operational. However, since it no longer provides SSD redundancy, you should contact your local Sophos partner to get further support.

Power Supply Cord Retention

Each power supply module is equipped with a plastic cord retention device.

The as-shipped state has the cord retention ring close to the power supply connector. This will need to be moved away from the power supply in order to plug in the cord. This can be accomplished by pulling the release tab away from the ring and sliding it along the cord ring guide.

If the cord retention device is to be used, plug the cord into the supply and place the cord in the retention ring and snap the ring shut, but not tight.

Slide the ring along the cord ring guide toward the power supply until it touches the cord connector.

Redundant Power Supply

The XGS 7500/8500 models are equipped with a 1+1 redundant power supply. The power supply system consists of two separate power supply units. This power supply system increases the availability of the security appliance, since a defective power supply unit can be exchanged easily and quickly during operation.

When the system is running error-free, the PS1 and PS2 LEDs on the front panel will show green. The LED on the rear of the power supply module will also show green. In the event of a defect in a power supply (including loss of AC power or out-of-specification AC power) the appropriate front panel LED will show red, and the LED on the rear of the power supply module will show orange.



Important note: If you need to change a power unit because of a defect, remember to remove the defective power unit from the power supply system, otherwise the whole security appliance will fail.

Protect yourself from potential burns by wearing protective gloves when exchanging a power supply unit.

Only use power units which you purchased directly from Sophos or from a Sophos distribution partner. Please remember that any warranty claims are voided for the security appliance if a defect has been caused by the use of power units which are not suited for the system.

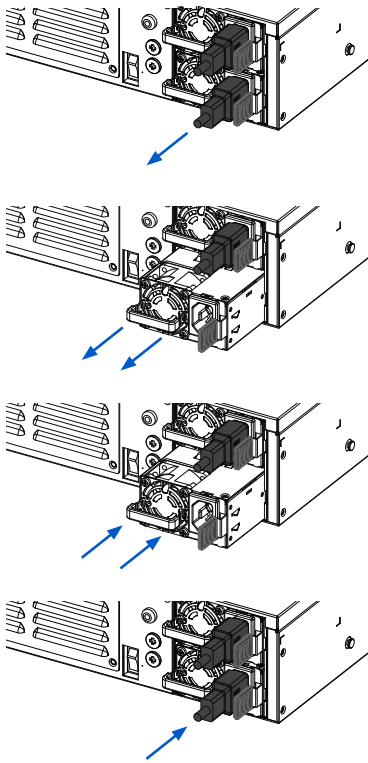

Exchanging a power supply unit

Please note: The power supplies are hot-swappable. i.e. if you want to exchange a defective power supply you don't need to remove the power cord from the primary power supply nor shut down the appliance.

Remove the cord, taking care to release the cord from the cord retention device.

Move the black lever of the power supply to be replaced toward the center of the chassis and, using the handle by the power supply fan, pull out the supply.

Plug in the replacement supply, making sure it is fully seated and that the black handle is moved toward the edge of the channel. If the black handle is not sufficiently moved, it will prevent the cord from being plugged in.

Plug the power cable back into the connector of the new power supply unit and check if the LED of the new power supply unit lights green.

Fix the cord retention.

SFP/SFP+/QSFP+/QSFP28 ports

The XGS 7500/8500 models offer a variety of SFP/SFP+/QSFP+/QSFP28 ports allowing you to plug in various GBICs (transceivers) to connect to high-speed fiber or copper networks. The abbreviation SFP GBIC stands for small form-factor pluggable GigaBit interface converter, a flexible interface which changes electronic signals into optical signals. The converters used with the appliance are often also called Mini-GBIC or New GBIC.

To use SFP/SFP+/QSFP+/QSFP28 ports, you will need the appropriate transceivers or DAC cables (combining cables and transceivers into one). These are not delivered with the appliance but are available either through your Sophos partner or from a 3rd party. There are different transceiver types, and the required type is determined by the existing network.

Caution: The SFP, SFP+, QSFP+ and QSFP28 ports use lasers to transmit signals over fiber optic cable. The lasers are compliant with the requirements of a Class 1 Laser equipment and are inherently eye-safe in normal operation. However, you should never look directly at a transmit port when it is powered on. Always install appropriate and UL approved Laser Class I Transceivers, rated 3.3Vdc, max 1 W for SFP/SFP+ and rated 3.3Vdc, max 1.5 W for QSFP+/QSFP28, in the fiber ports before using the fiber ports.

Installing a SFP/SFP+/QSFP+/QSFP28 module

Please read the operation manual for the module. Carefully insert the module into the port until it engages. The interface is immediately ready for use.

Removing a SFP/ SFP+/QSFP+/QSFP28 module

1. Remove the optical cable from the module which you wish to remove.
2. Remove the module carefully from the port.

Depending on when you purchased your module, it may have any of three different release mechanisms: a plastic tab on the bottom of the module, a wire bail, or a plastic collar around the module.

Please note: All transceiver modules are hot-swappable. i.e. if you want to remove/exchange a transceiver you don't need to shut down the appliance. Please read the operation manual to the module.

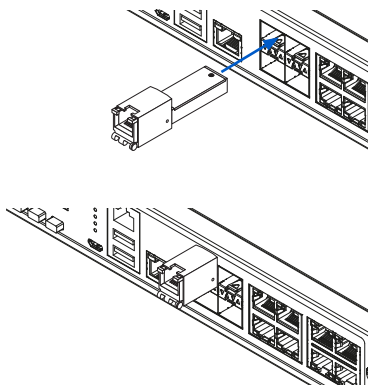

Serial Console

You can connect a serial console to either the RJ45 or micro USB COM port to access the CLI. Only one port can be used at any time. If both ports are connected then the micro USB port will take precedence. You can use, for instance, the Hyperterminal terminal program which is included with most versions of Microsoft Windows to log on to the appliance console. If you want to connect to the Micro-USB COM port please use the supplied cable. If you want to connect to the RJ45 COM port please use a RJ45 to DB9 Adapter cable (not provided with the unit). The Pin-out for this cable is shown in the table below.

Sophos RJ45 Pinout

This pinout is compatible with Cisco Straight [X2] pinout serial cables.

Pin number	Function	Direction
1	RTS	Output
2	DTR	Output
3	TXD	Output
4	Ground	N/A
5	Ground	N/A
6	RXD	Input
7	DSR	Input
8	CTS	Input

The required connection settings are:

- **Bits per second:** 38,400
- **Data bits:** 8
- **Parity:** N (none)
- **Stop bits:** 1

Access via the serial console is activated by default on ttyS0. The connections of the appliances and the respective functionality are listed in chapter 'Operating Elements and Connections.'

Please Note: If you are connecting to the Micro USB port and it doesn't show up as COM port but as unknown hardware in your system, please download a Micro USB Driver from <https://ftdichip.com/drivers/d2xx-drivers/>.

United Kingdom and Worldwide Sales
Tel: +44 (0)8447 671131
Email: sales@sophos.com

North American Sales
Toll Free: 1-866-866-2802
Email: nasales@sophos.com

Australia and New Zealand Sales
Tel: +61 2 9409 9100
Email: sales@sophos.com.au

Asia Sales
Tel: +65 62244168
Email: salesasia@sophos.com